

Abwicklung/ Template

Modell: Kaffeetasse GR45

Größe/ printing area: Druck am Henkel offen / Print open at the handle

max. Druckfläche: Länge 225 mm, Höhe 90 mm

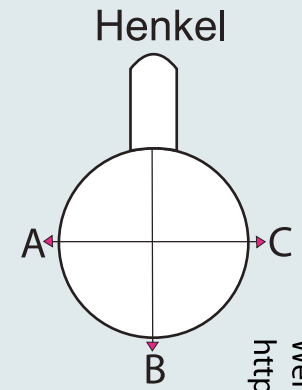

A

Henkel links
handle position left side

B

Mitte - gegenüber Henkel
handle position opposite

C

Henkel rechts
handle position right side



Weitere Informationen zum Thema **Tassen bedrucken** finden Sie unter:
<http://www.werbe-tassen-mit-druck.de>

